

NORTH™ EXPLORER

ASSEMBLY INSTRUCTIONS MONTAGEANLEITUNG

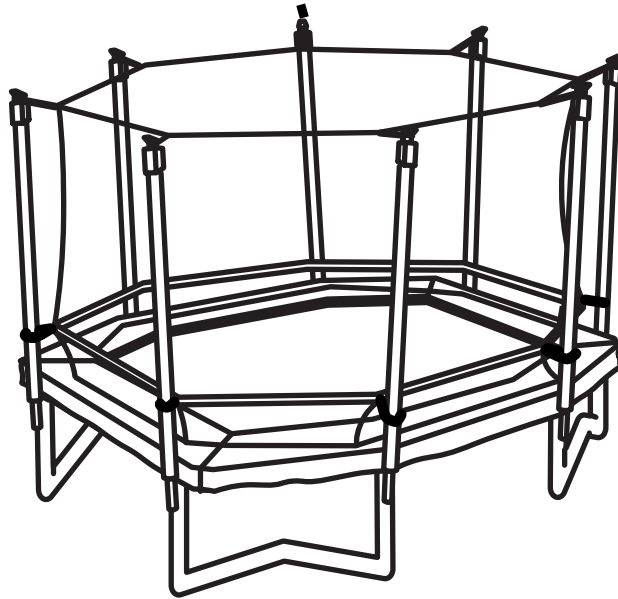

ROUND

430

360

300



OVAL

500

420

350



RECTANGULAR

460

All rights reserved 2021. Avero AB ©
All artwork and illustrations are owned by Avero AB, Sweden.
Copying or reusing them is prohibited by law.
For more information, contact us at info@northtrampoline.com

Alle Rechte vorbehalten 2021. Avero AB ©
Alle Grafiken und Illustrationen sind im Besitz von Avero AB, Schweden.
Deren Kopieren oder Weiterverwendung ist gesetzlich verboten.
Kontaktieren Sie uns unter info@northtrampoline.com
um weitere Informationen zu erhalten.

EXPLORER

300, 360, 430

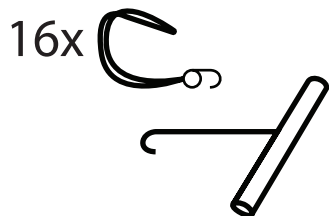
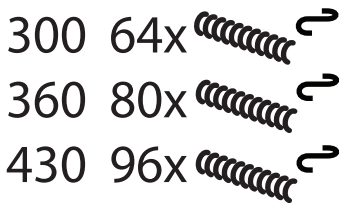
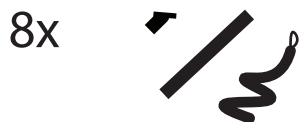
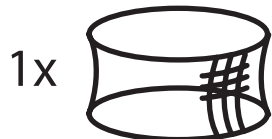
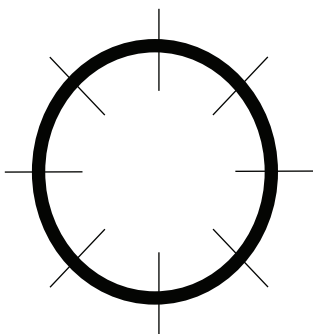

EXPLORER

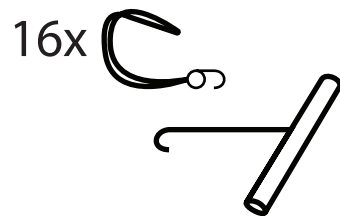
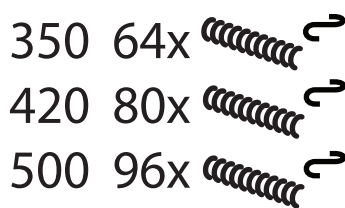
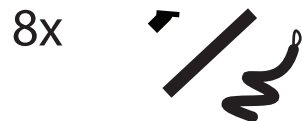
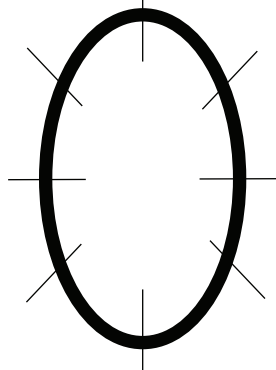

350, 420, 500

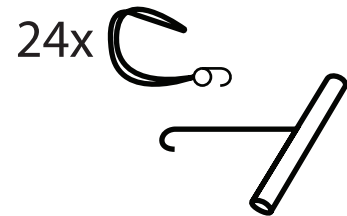
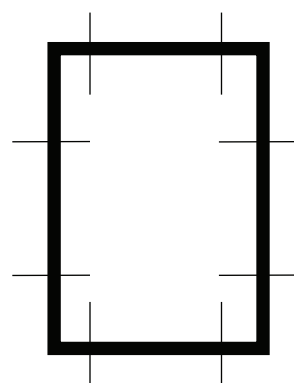

EXPLORER

460





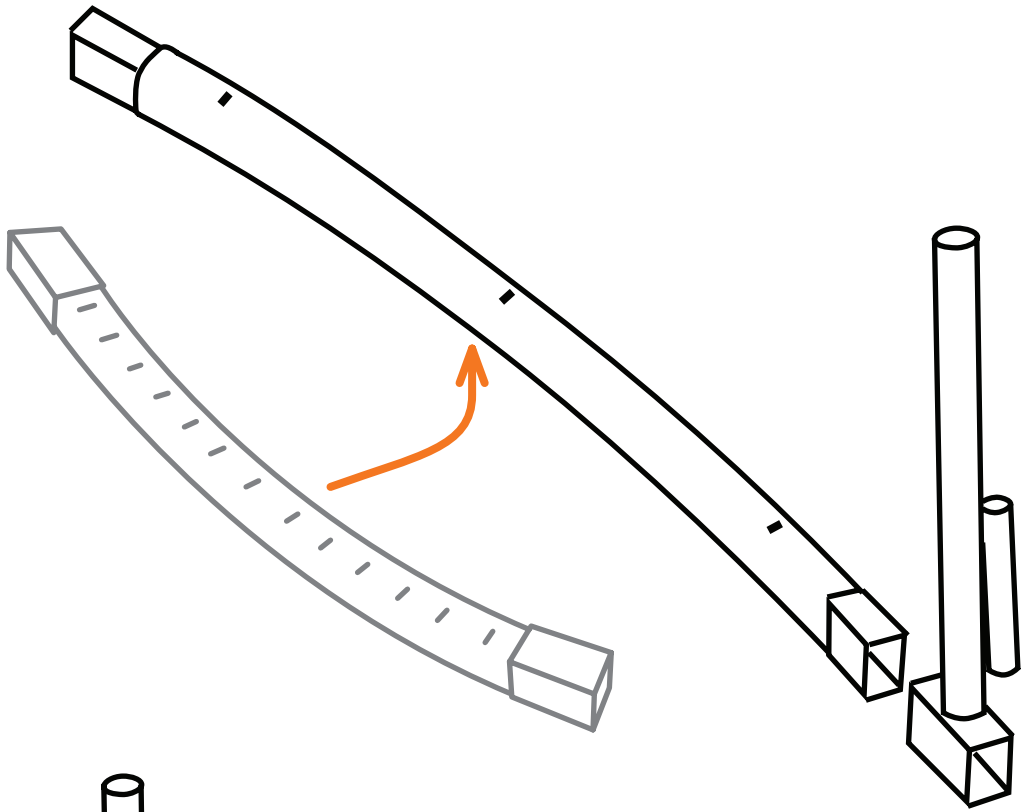

1  
8x

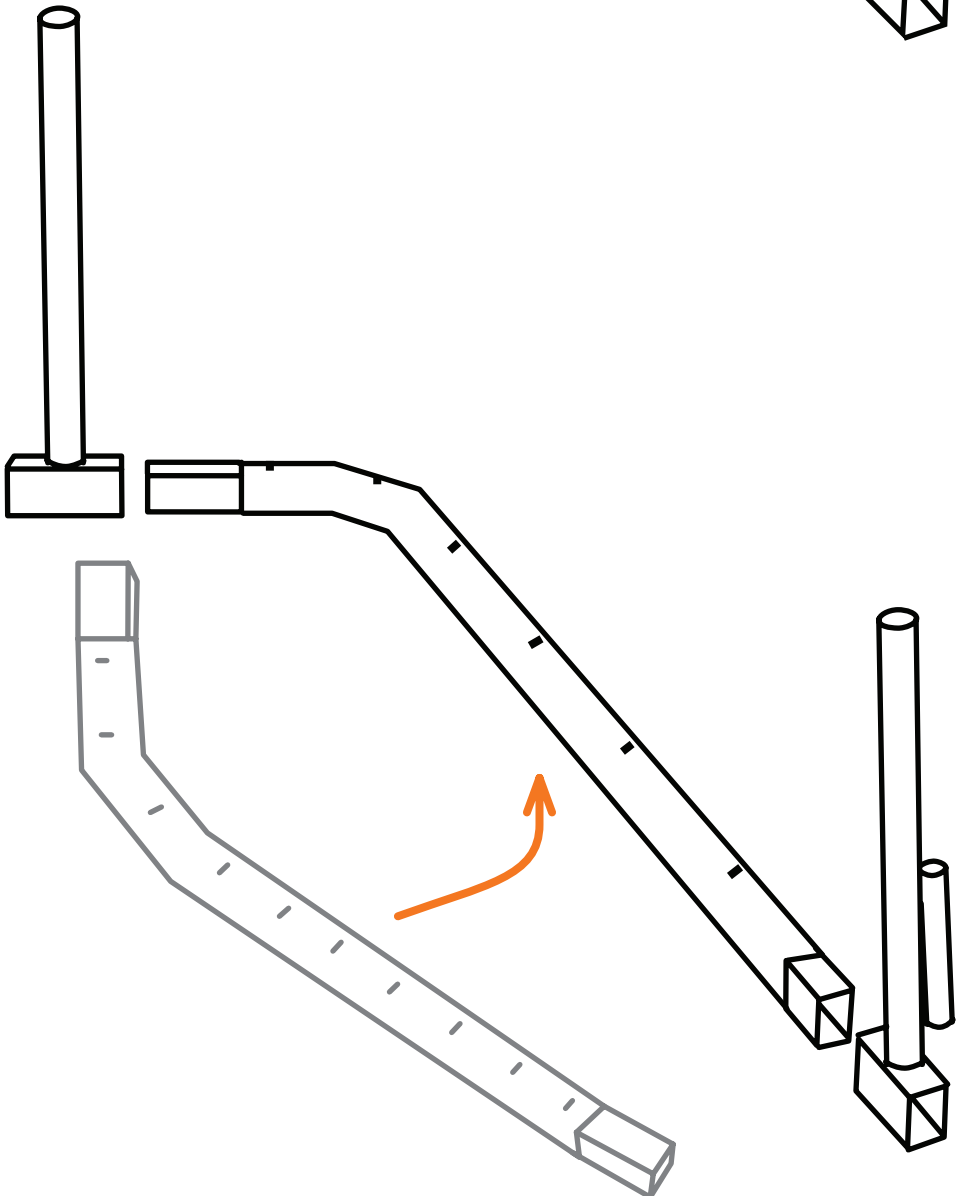

1 
4x



2  

 2x  + 
2x  + 

8x

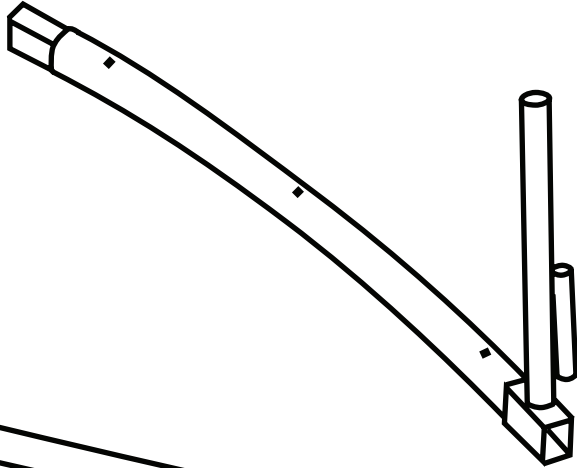
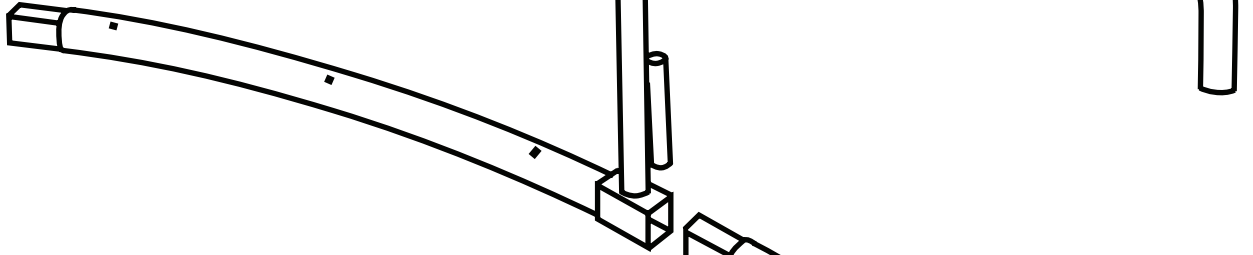
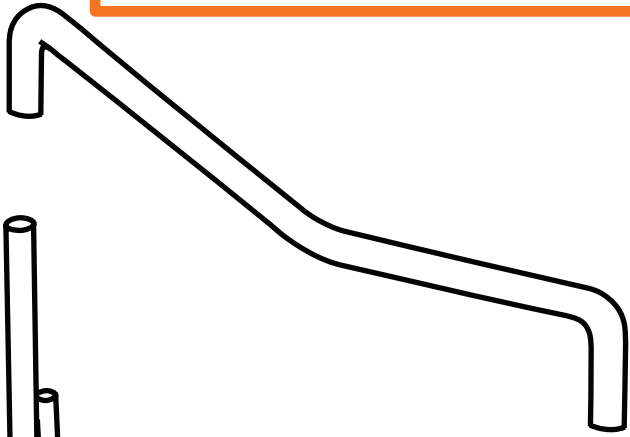
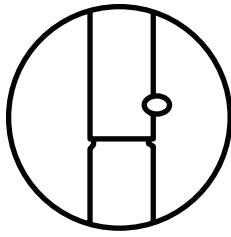

2 

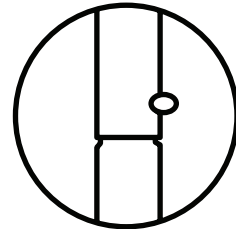
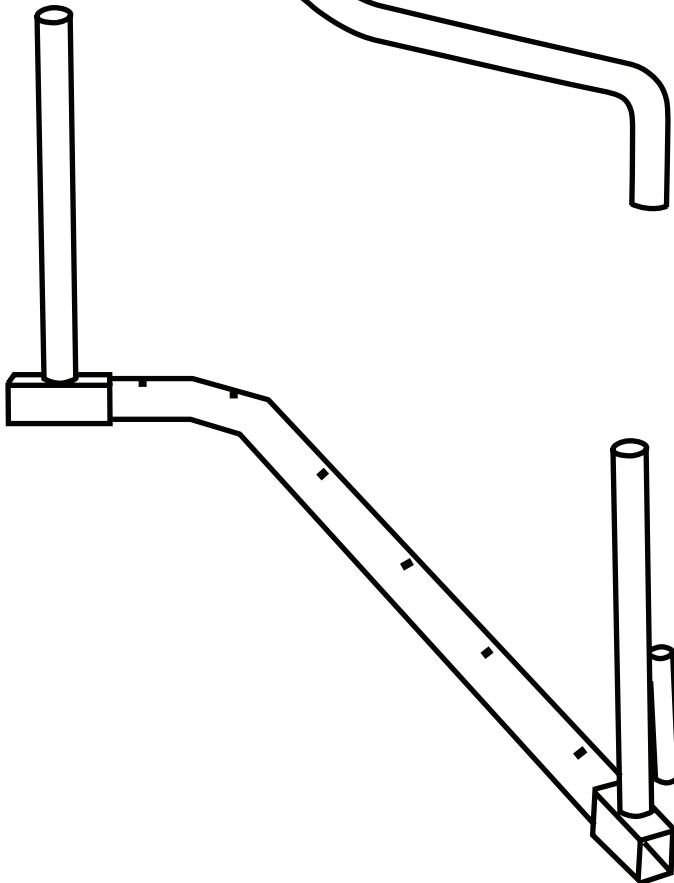
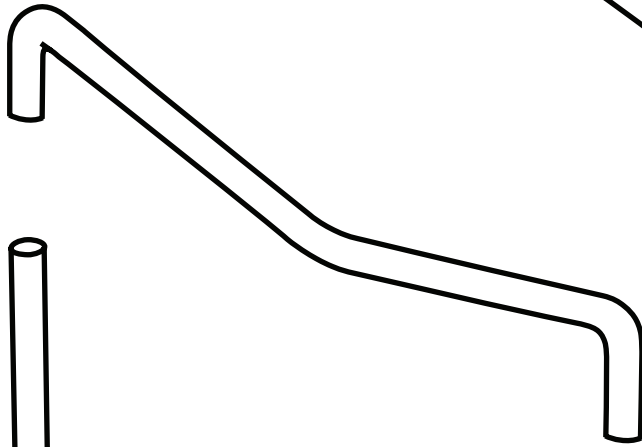

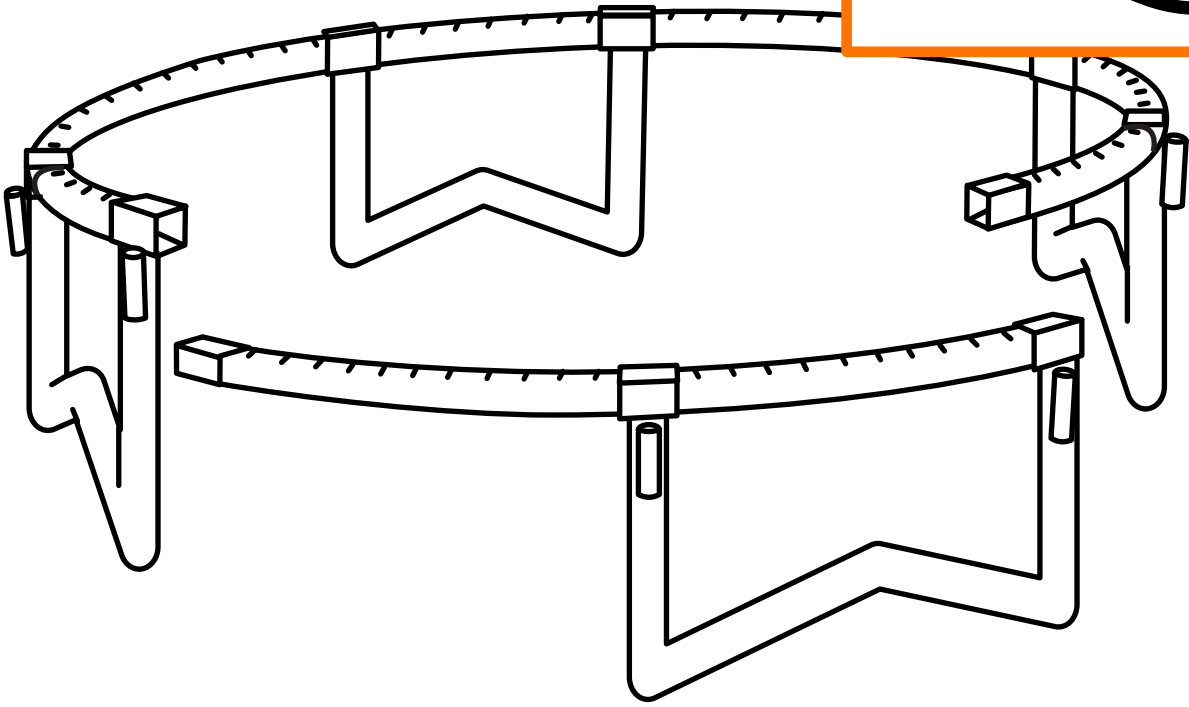
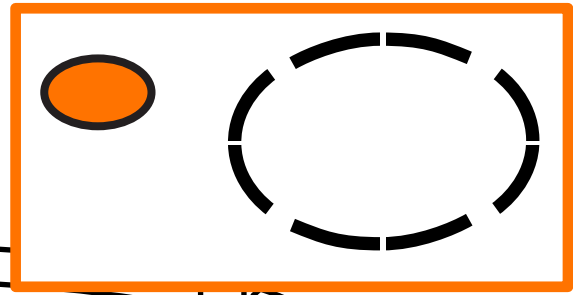

8x

3 ● ●

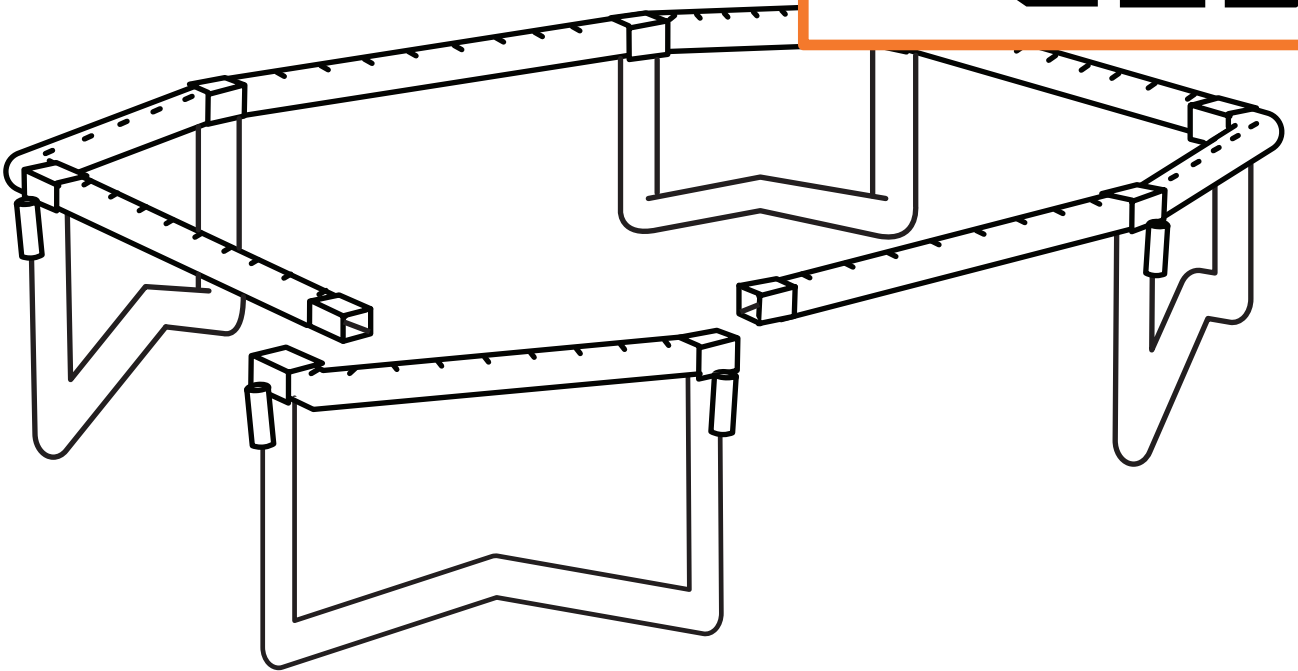
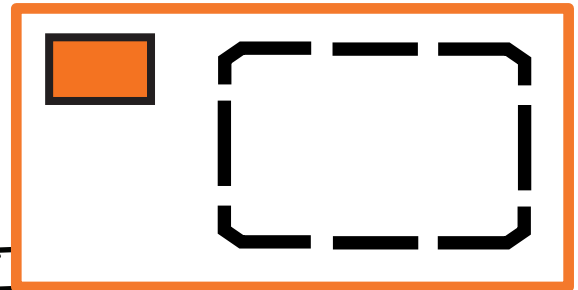

3 ■



4

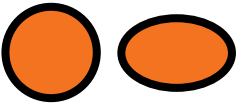
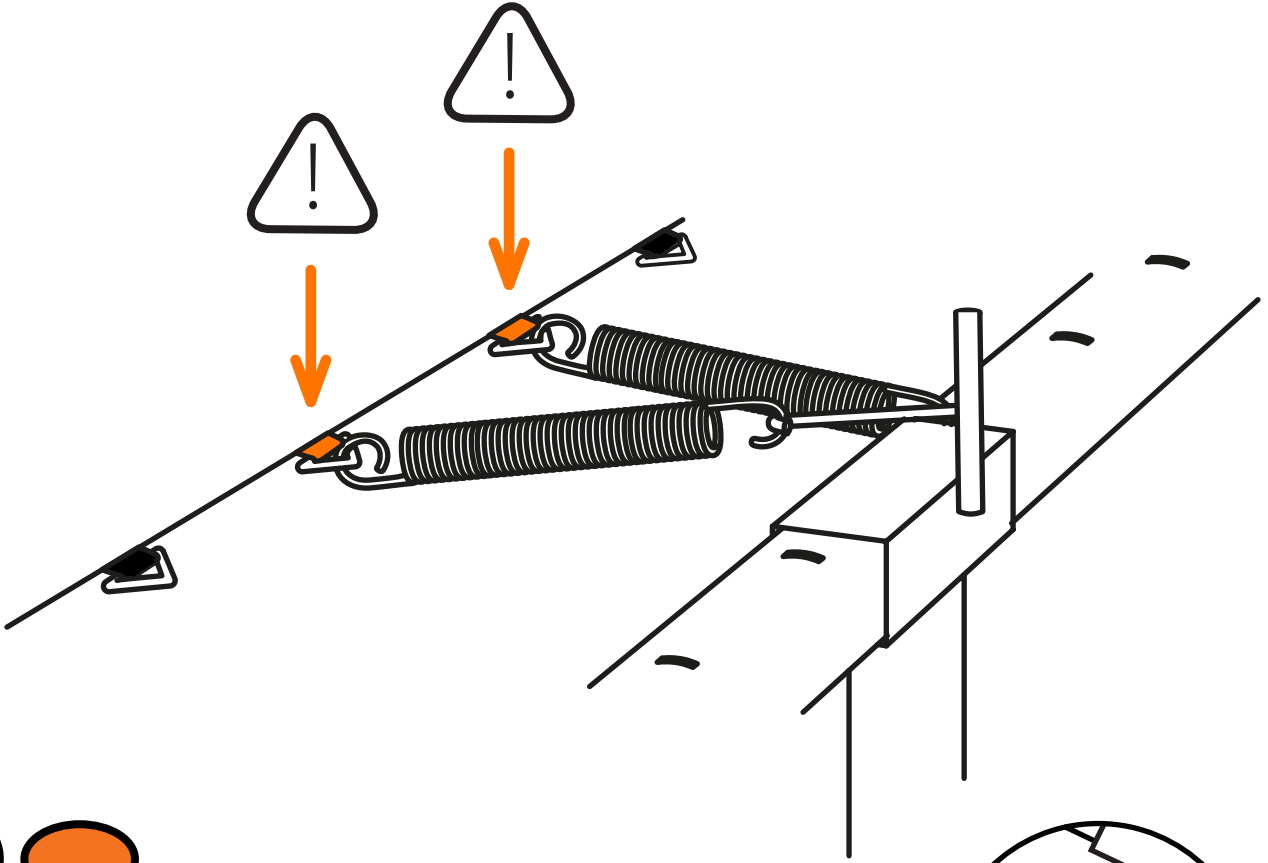

2

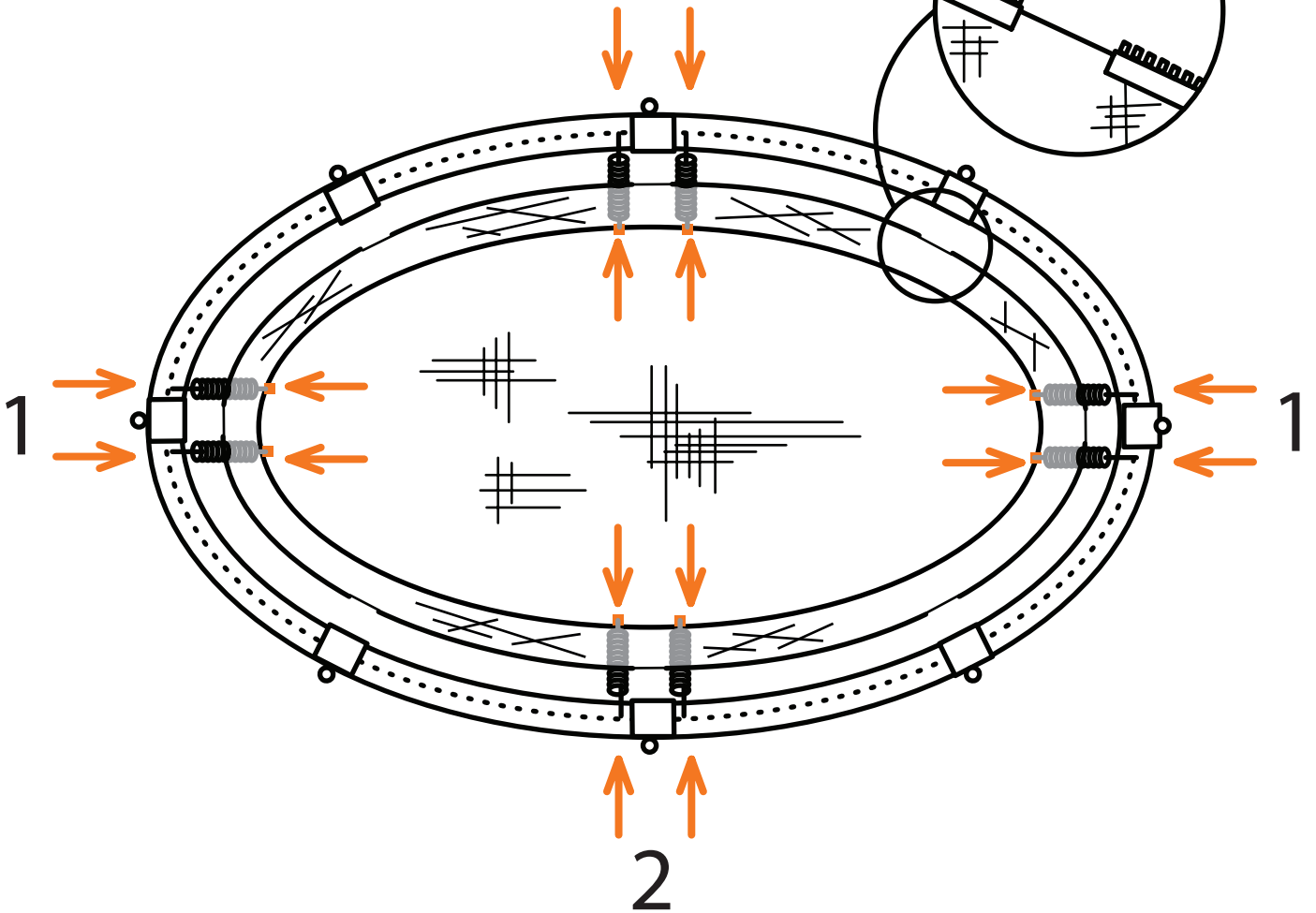
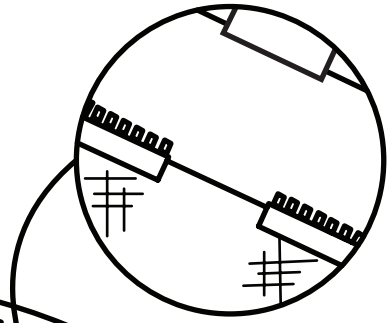

5 ○ ◌ ◻

0%

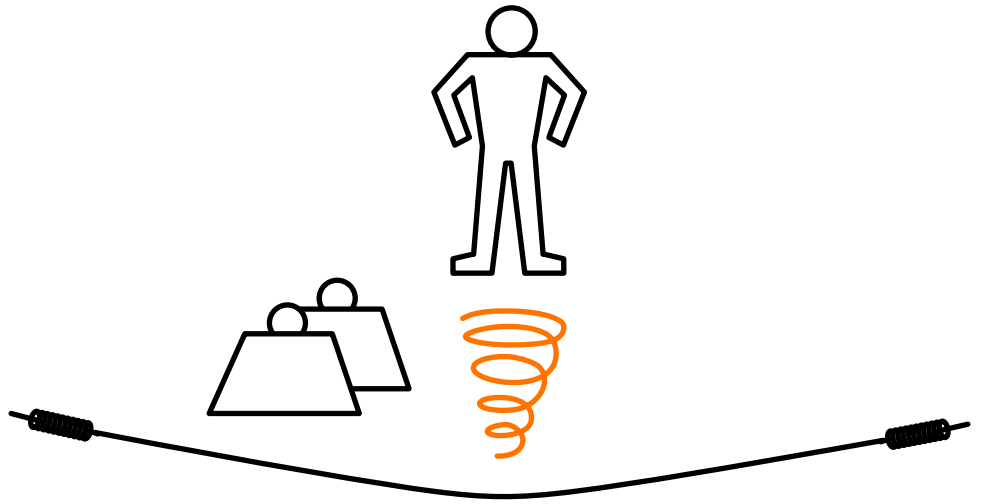

?

50%

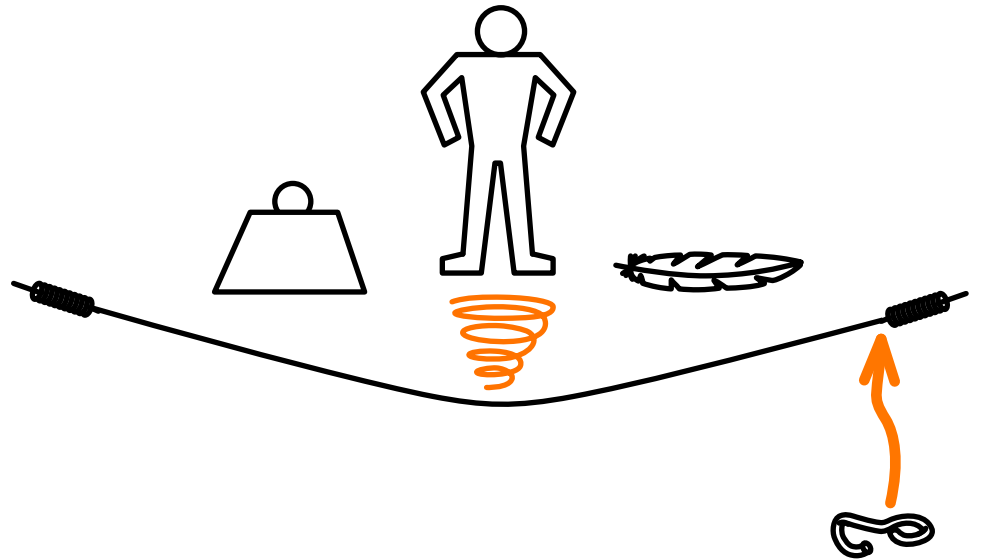

?

100%

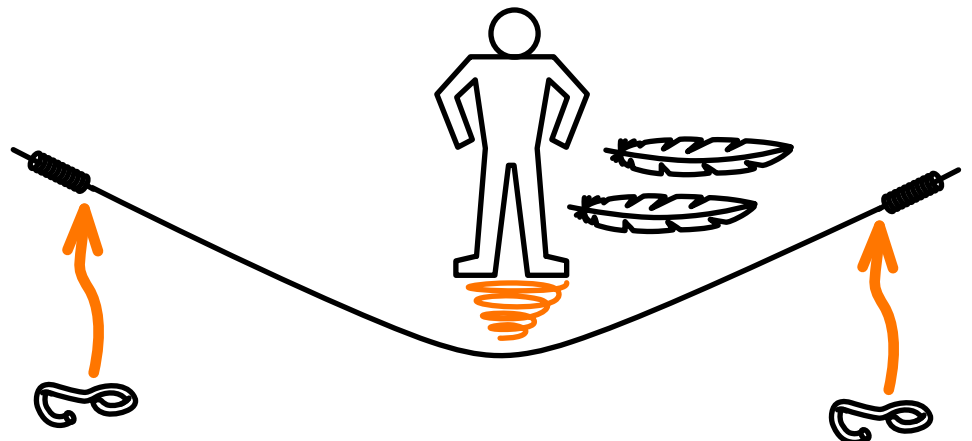

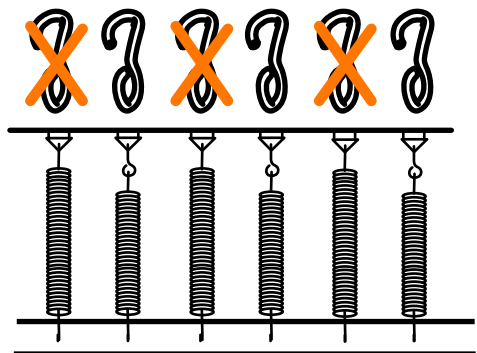
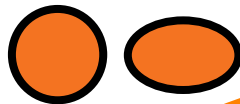
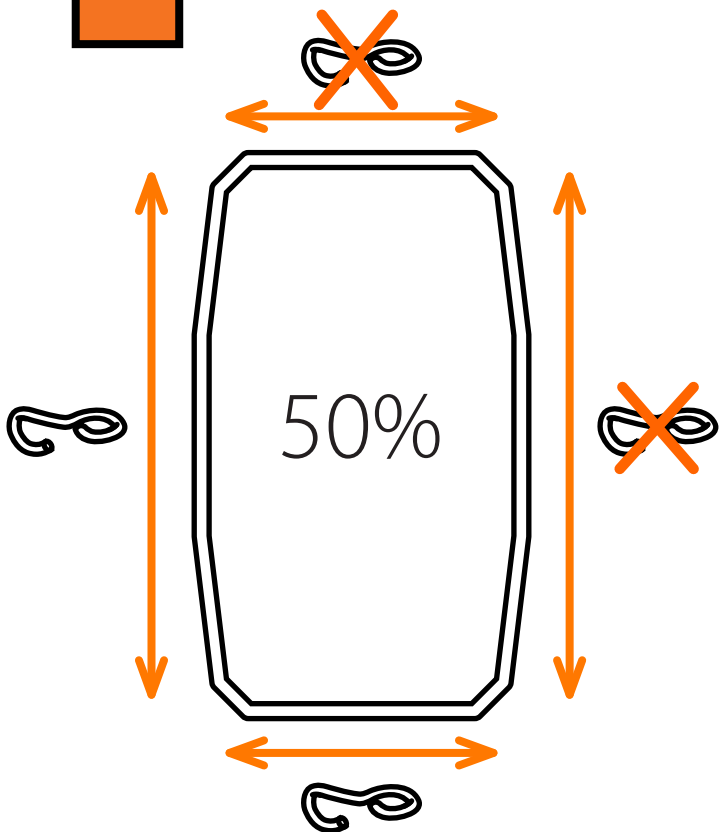
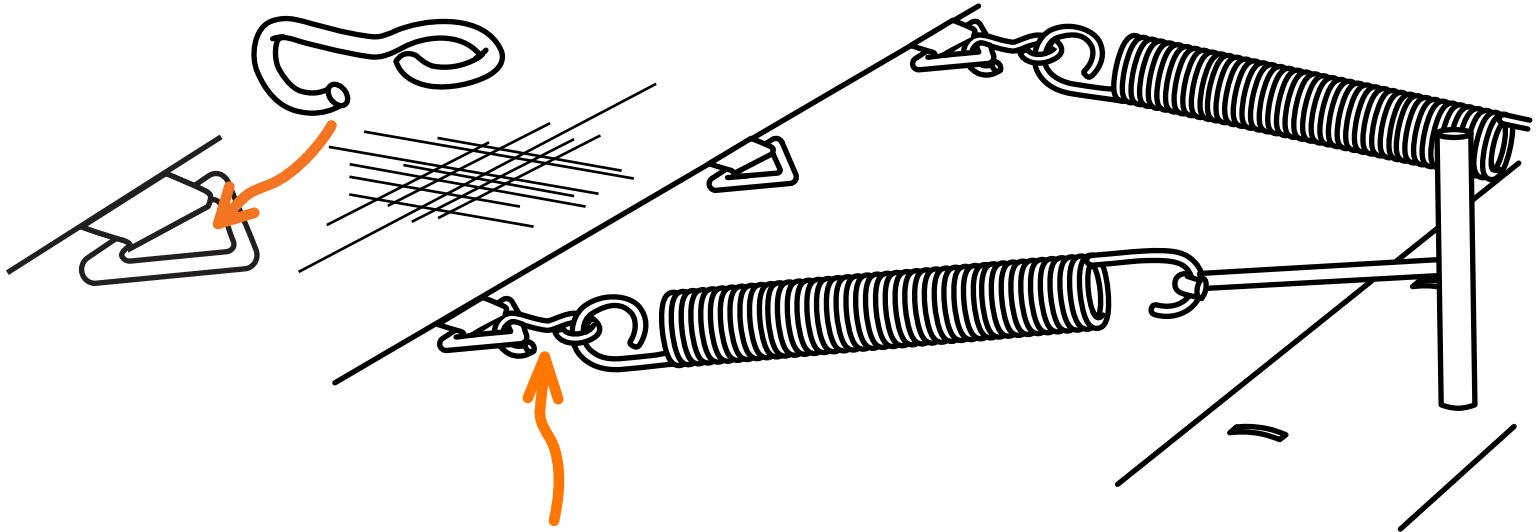
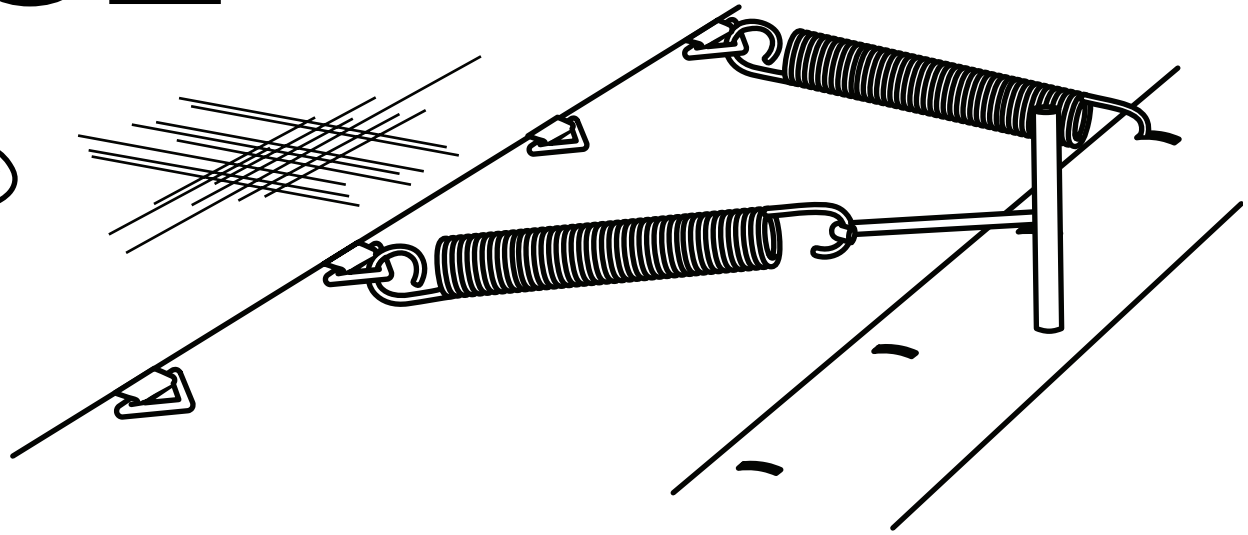
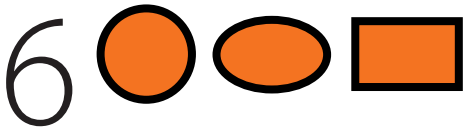



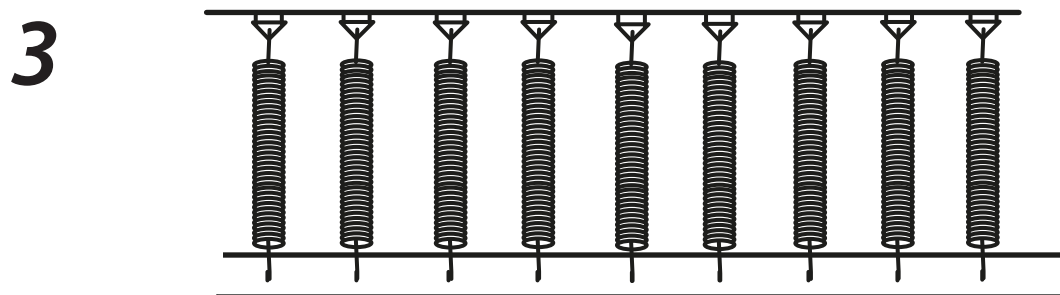
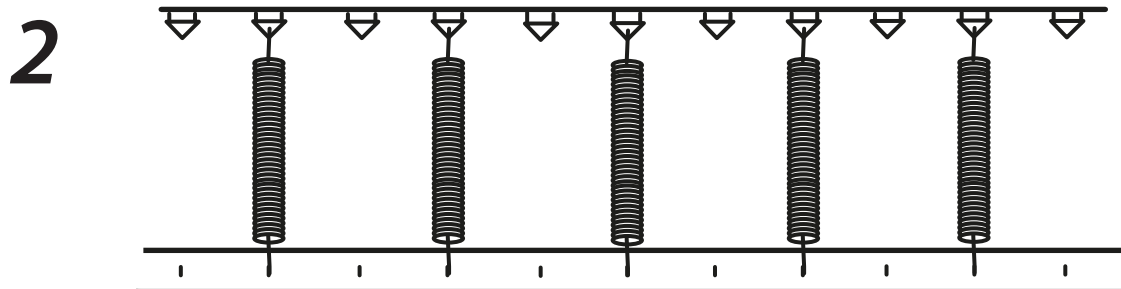
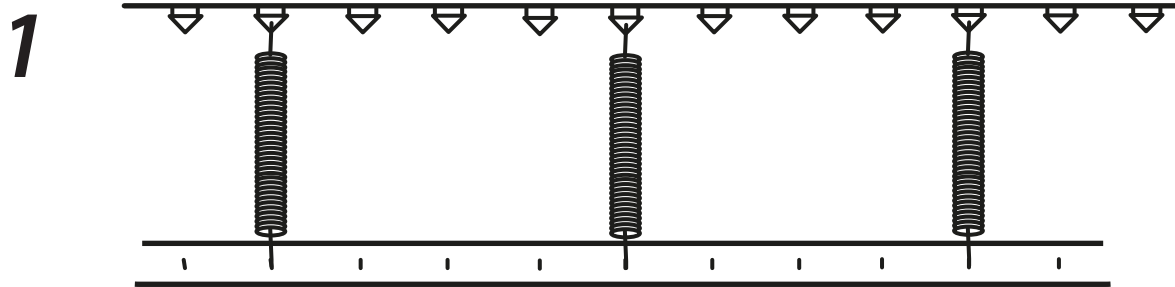
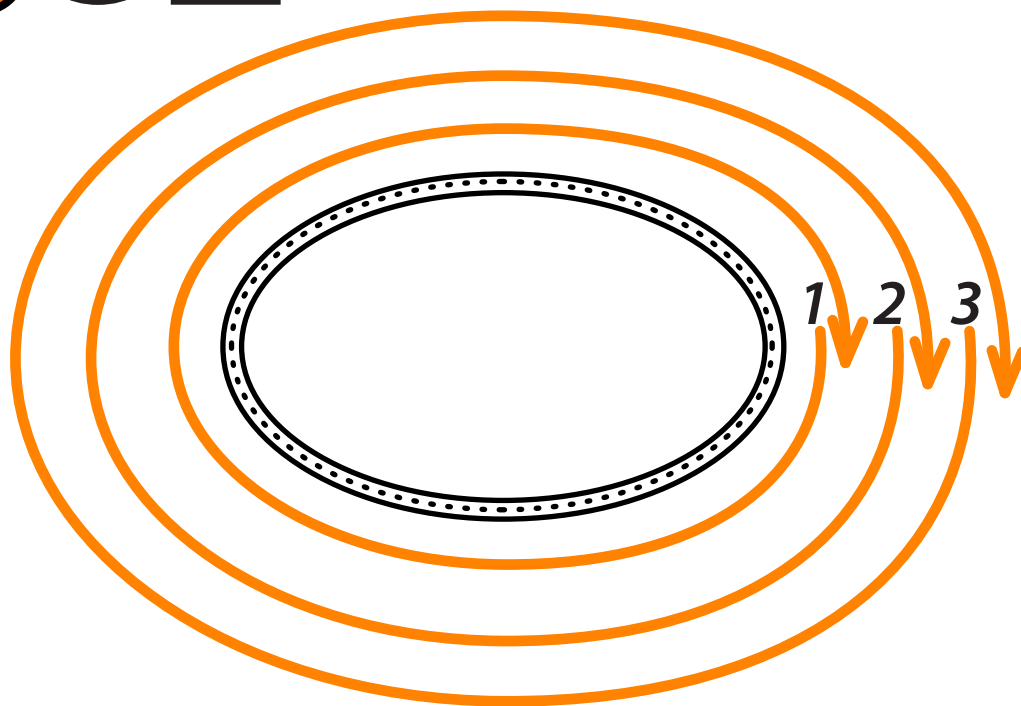

7 ○ ◌ ◻

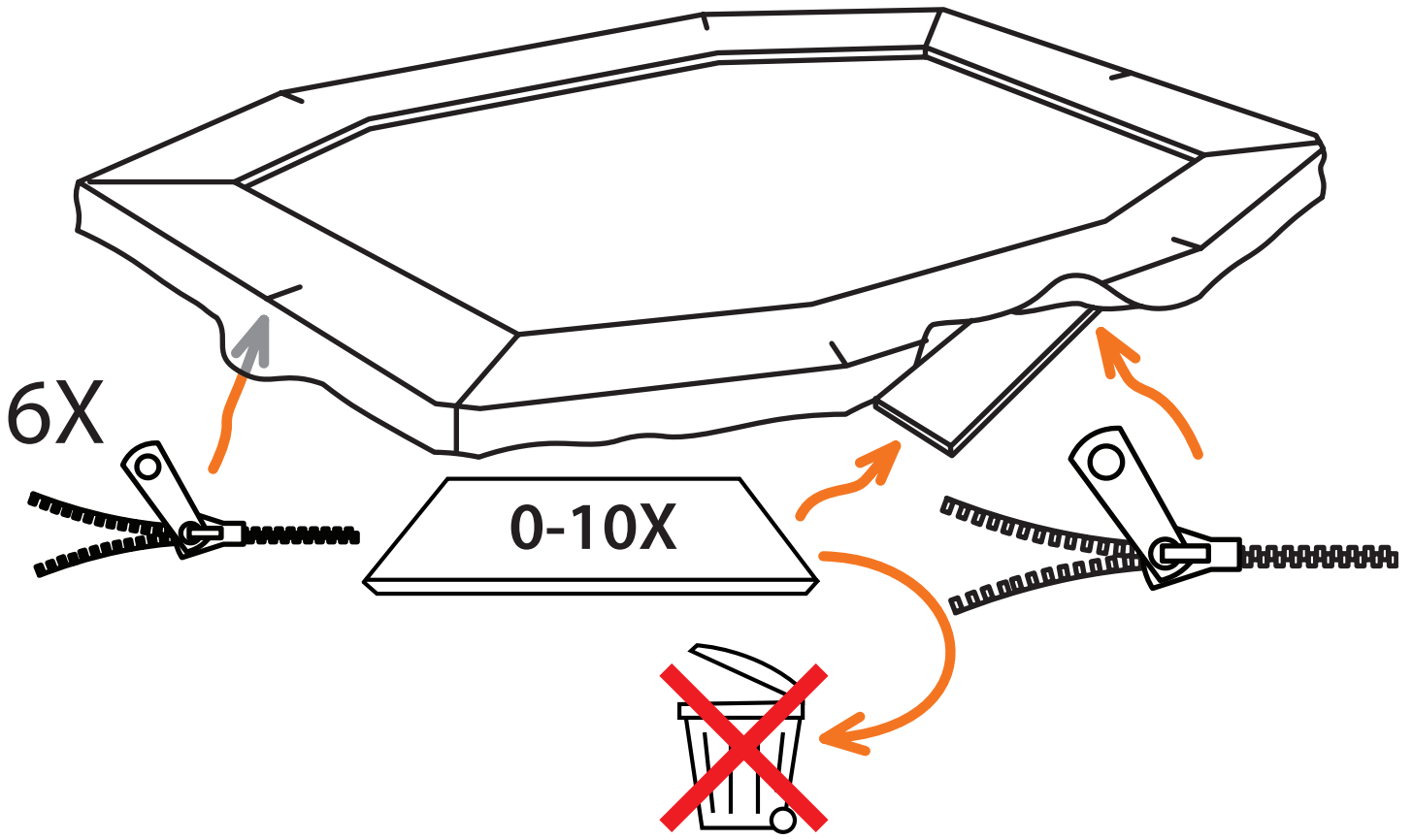

8 



9   

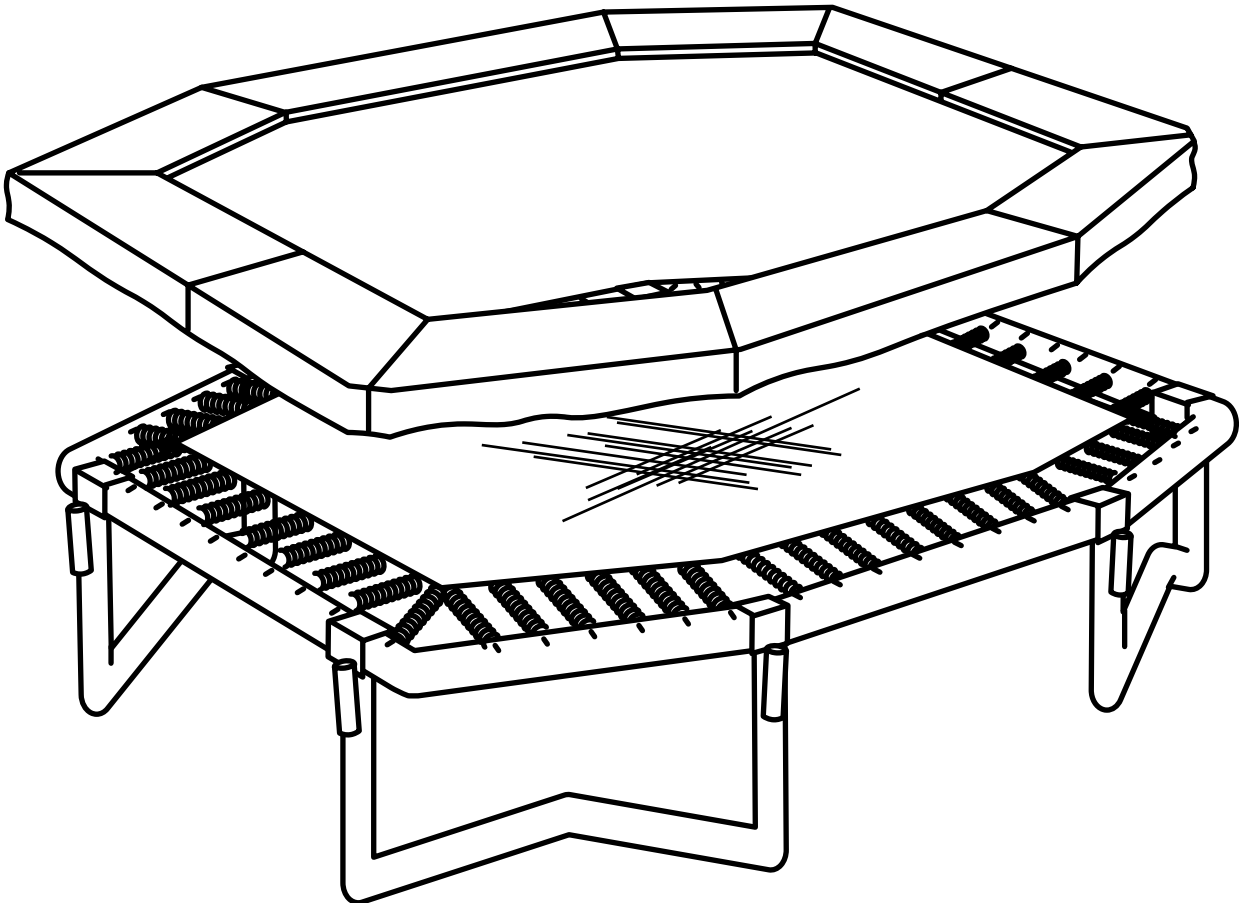

10 ● ○ ■

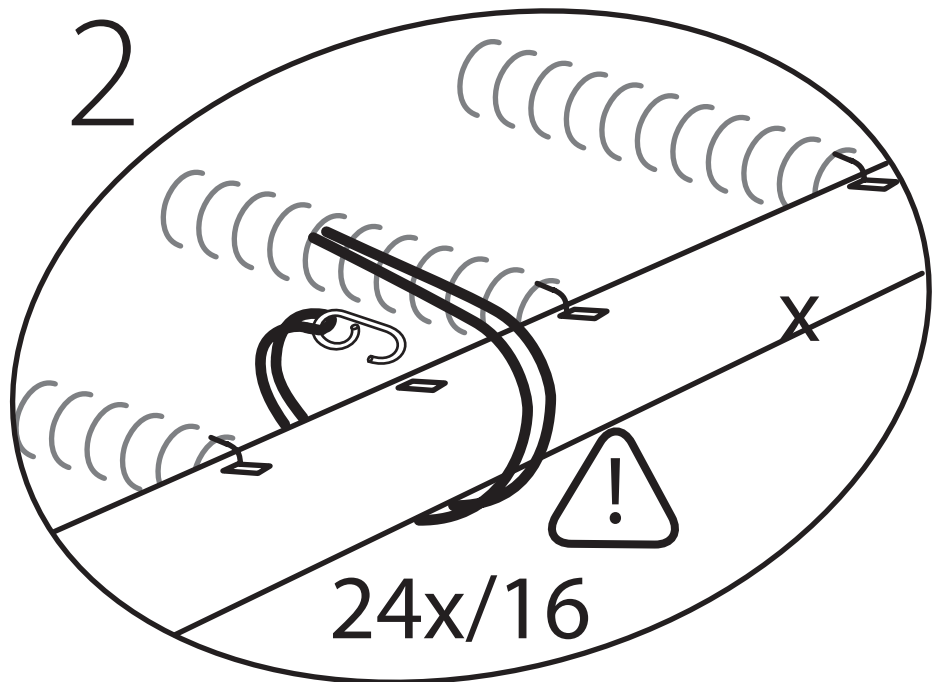
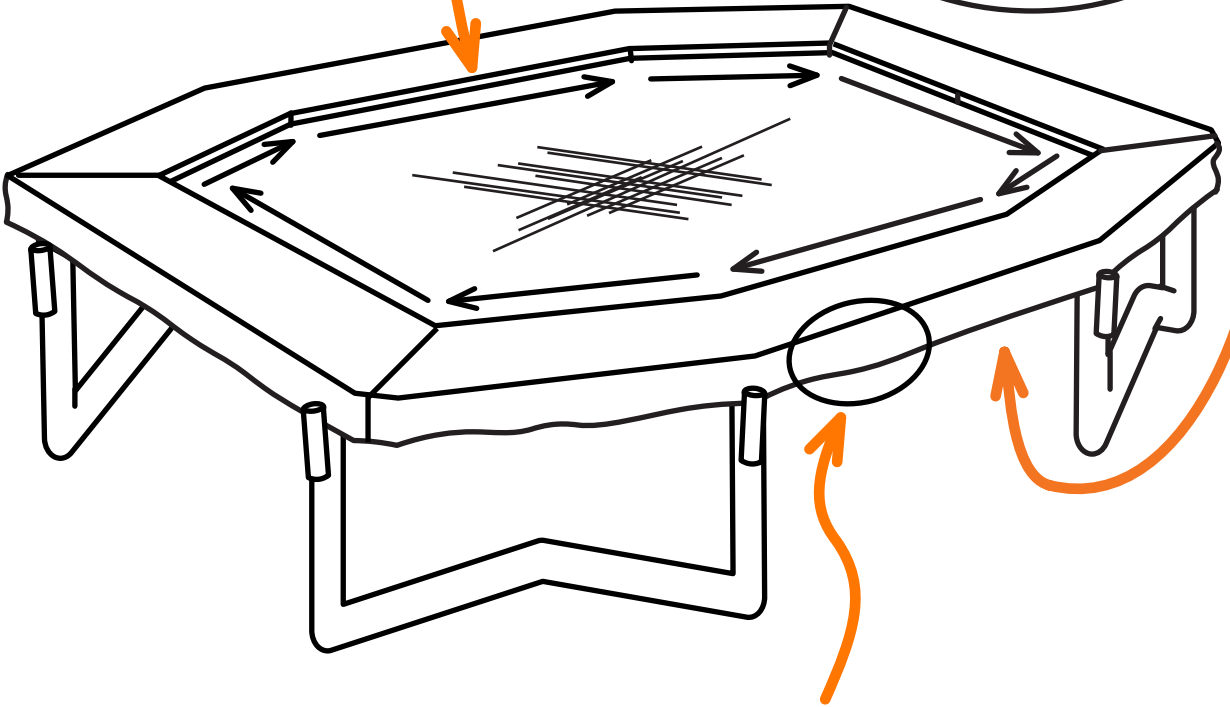
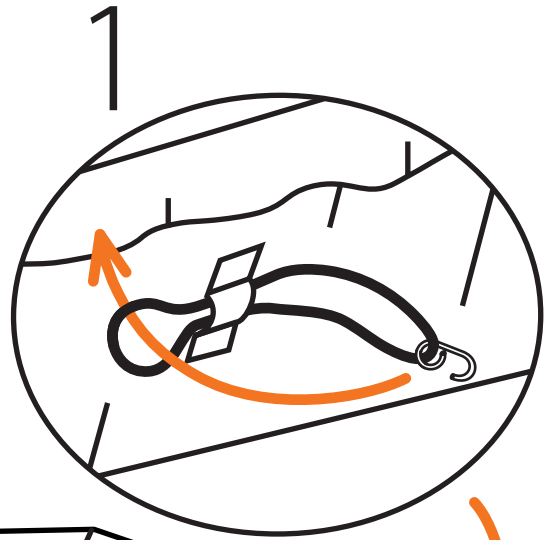

1 1 ○ ○ □

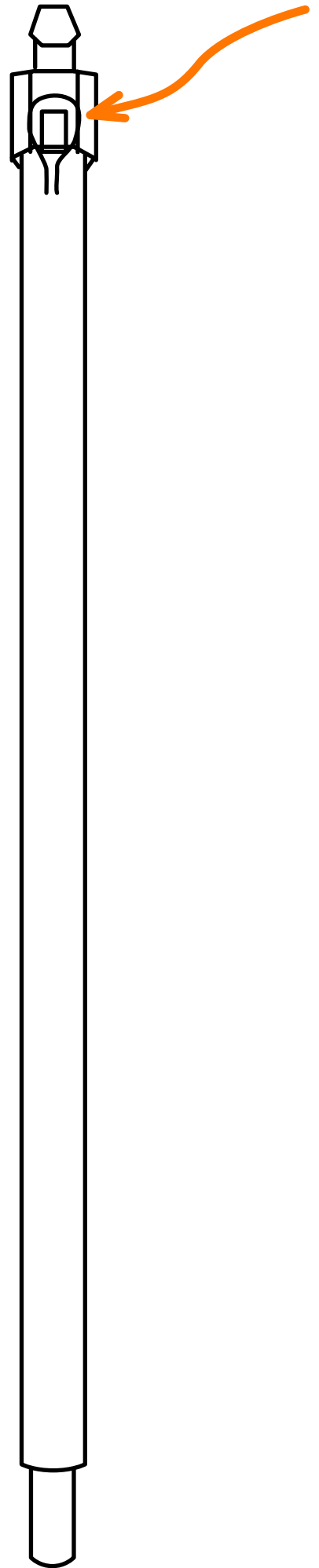
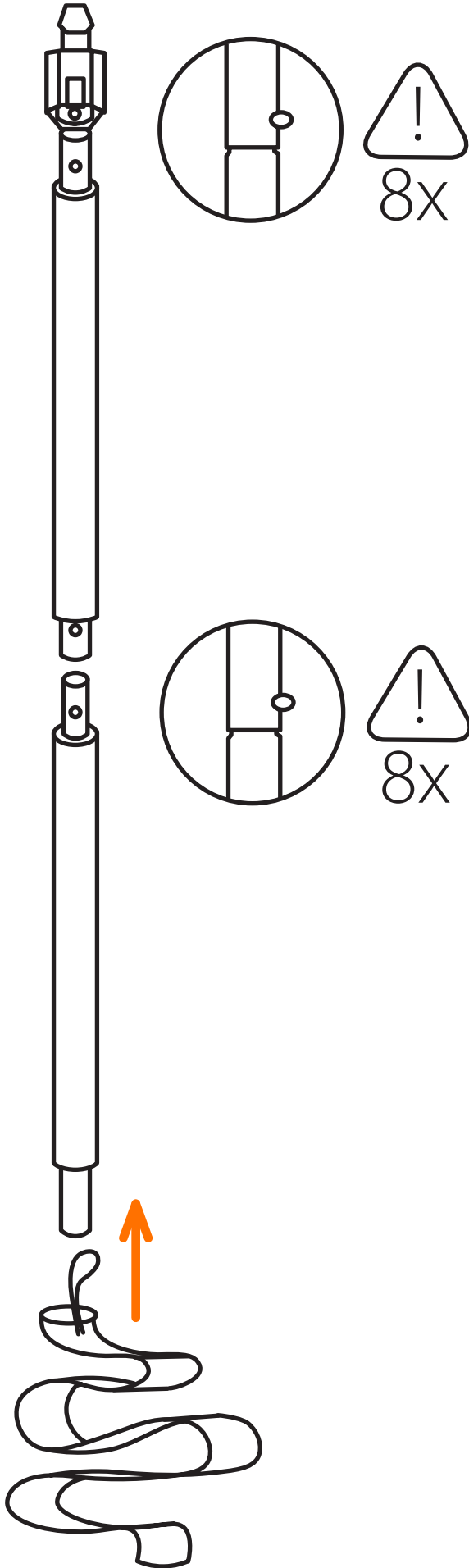

12 ○ ○ □

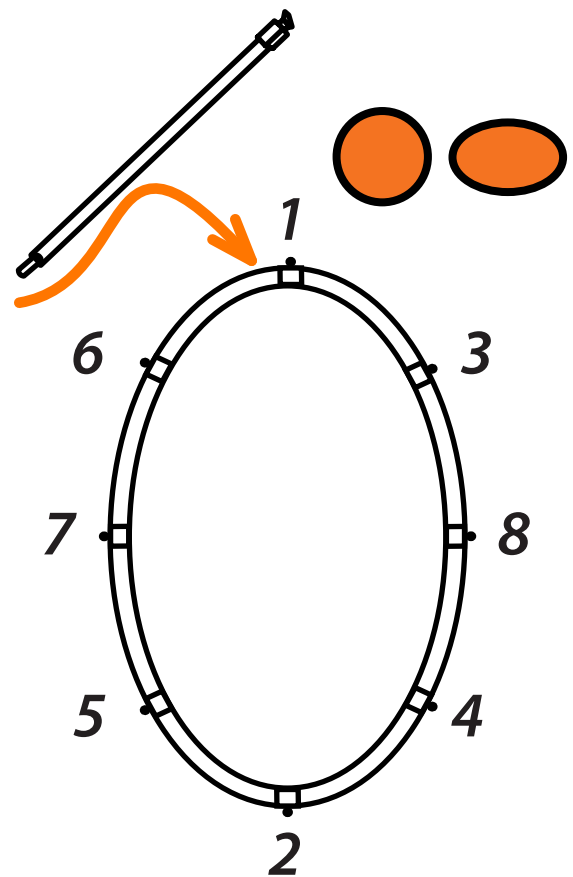
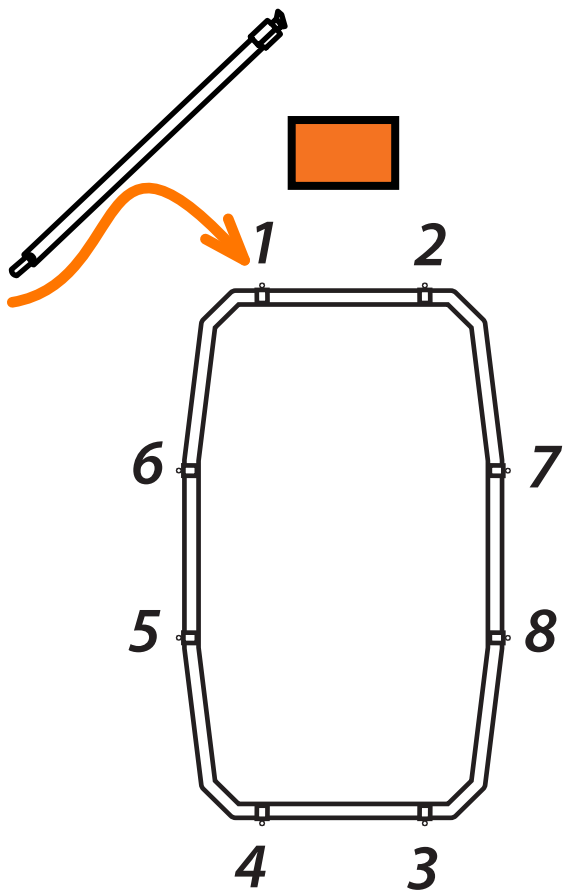
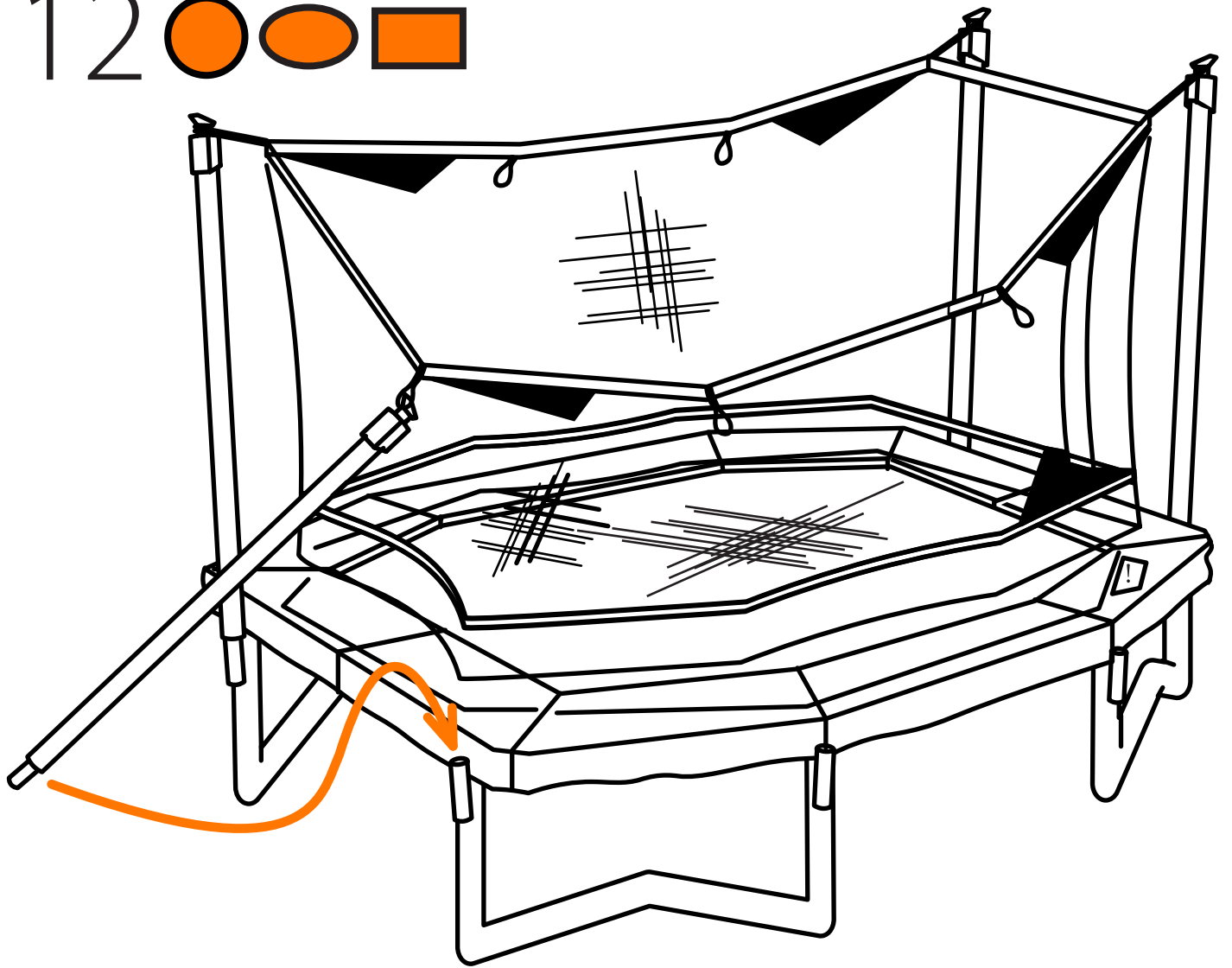

12 ○ ○ □

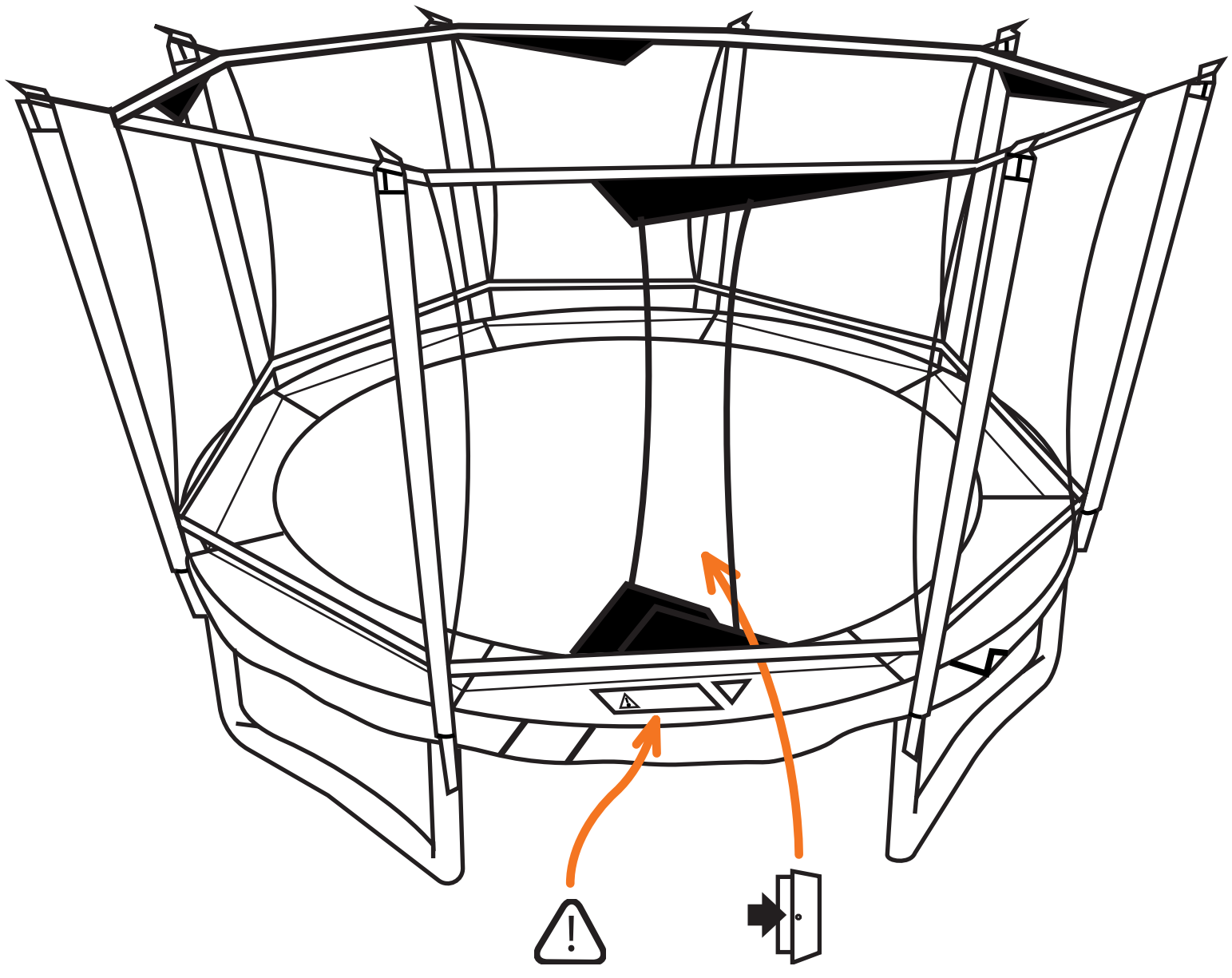

13 ○ ● ◻

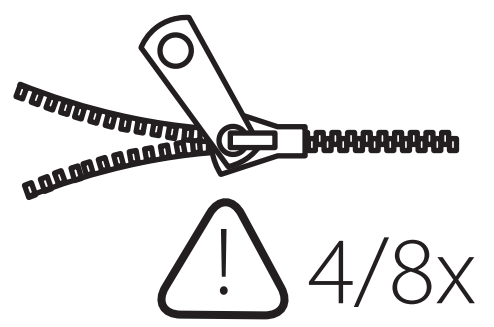
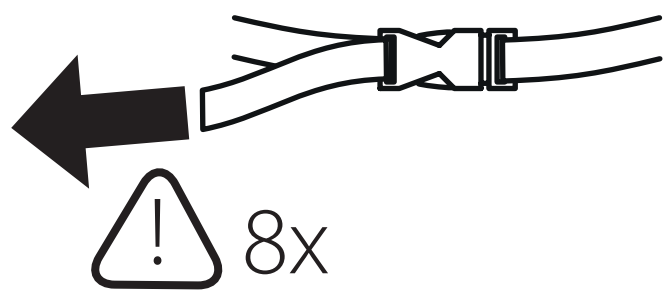
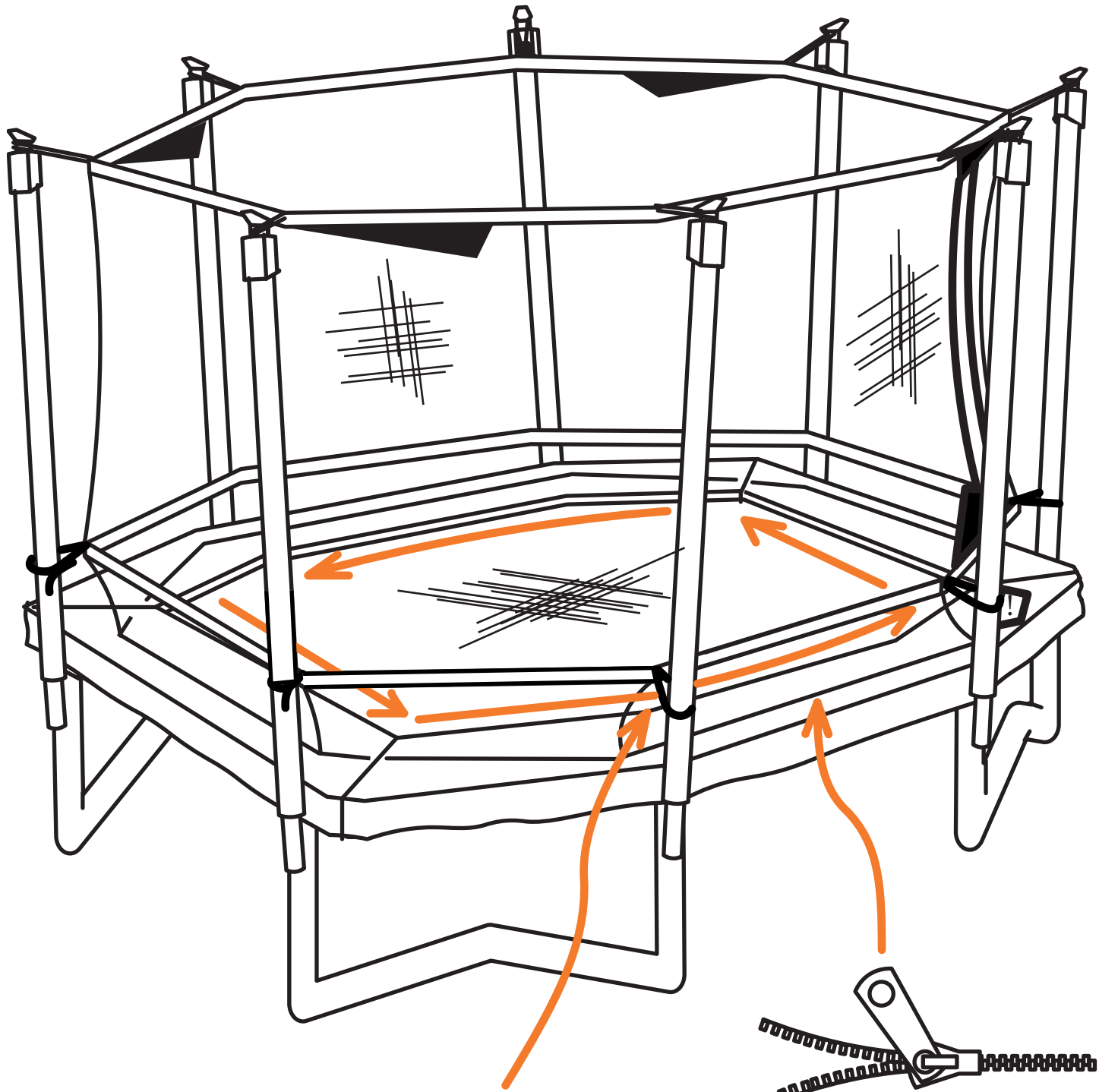

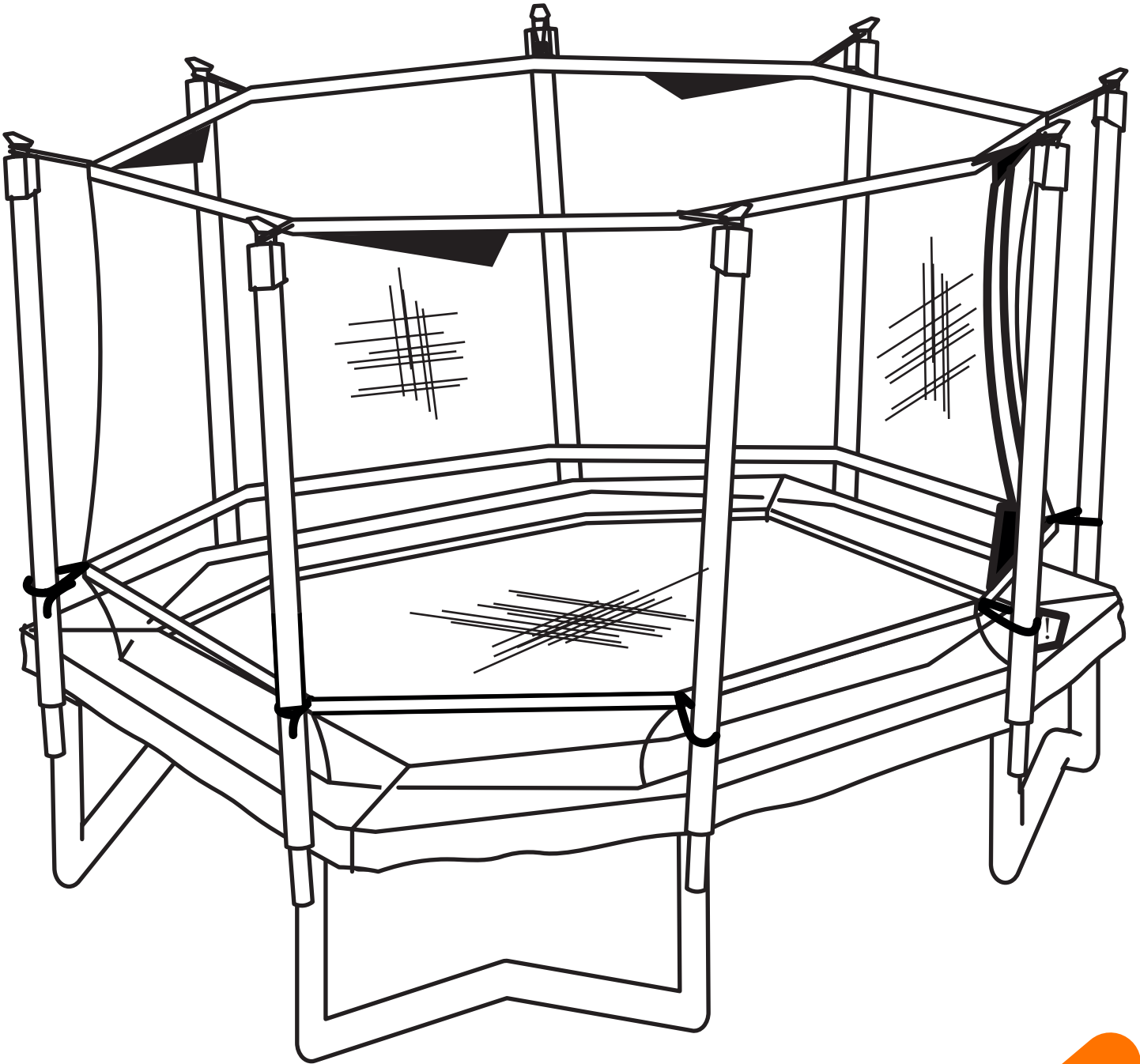

NORTH™ EXPLORER

ENG: DISSEMBLY

To disassemble the trampoline, follow the assembly steps in reverse order.

Do not attempt to disassemble any trampoline frame components before the springs and the trampoline mat have been removed. Use gloves to protect your hands from pinch points during disassembly.

SV: NEDMONTERING:

För att nedmontera studsattan/skyddsnetet, följ de olika stegen för montering i omvänd ordning. Försök inte att ned-montera någon del av studsattans ram innan fjädrarna och hoppduken har avlägsnats. Använd handskar för att skydda dina händer från att klämmas under nedmonteringen.

NO: demontering:

For å demontere trampolinen, følg monteringsstrinn i omvendt rekkefølge. Ikke forsøk å demontere noen rammekomponenter på trampolinen før fjærene og hoppeduken er fjernet. Bruk hansker for å beskytte hendene for klemskader ved demontering.

DK: NEDMONTERING:

For at demontere trampolinen/sikkerhedsnettet skal man følge trinene i modsat rækkefølge. Forsøg ikke at demontere nogen af trampolinrammens dele, før fjedre og hoppedug er blevet fjernet. Bær handsker for at undgå at få klemt fingrene under demonteringen.

FI: PURKAMINEN :

Pura trampoliini seuraamalla kokoamisvaiheita päinvastaisessa järjestyksessä. Älä yritä purkaa trampoliinin rungon osia ennen kuin jouset ja trampoliinimatto on poistettu. Käytä käsineitä suojataksesi kätesi puristuskohdilta purkamisen aikana.

DE: DEMONTAGE:

Zur Demontage des Trampolins/Sicherheitsnetzes befolgen Sie einfach die Montageschritte in umgekehrter Reihenfolge. Versuchen Sie keinesfalls, ein Rahmenteil des Trampolins zu demontieren, bevor Sie die Federn und das Sprungtuch entfernt haben. Tragen Sie Handschuhe, um Ihre Hände während der Montage vor Quetschungen zu schützen.



